



SIGMATEST® 2.068

- ✓ Determining physical and technological material properties
- ✓ Monitoring the condition of highly stressed parts
- ✓ Material-mix testing
- ✓ Sorting of metals and alloys
- ✓ In-process inspection in industrial, metallurgical and metalworking plants
- ✓ Incoming inspection
- ✓ Aircraft maintenance inspection
- ✓ Verification of the age-hardening condition of aluminum used in aircraft construction



SIGMATEST 2.068 - The eddy-current instrument for conductivity measurements on all non-ferrous metals

Application

- * Absolute measurement of the electrical conductivity of non-ferrous metals
- * Determination of metal purity
- * Monitoring of metal homogeneity
- * Monitoring of strength and hardness
- * Determination of the phosphorus content in copper
- * Monitoring of the casting process (polarization) of copper
- * Monitoring of separation processes, e.g. for Cu-Cr alloys
- * Measurements possible at high material temperature by lining with ceramic wafers up to a thickness of 500 µm (.02 inch)
- * Detection of heat damage in aluminum alloys (e.g. in the aircraft maintenance)
- * Scrap sorting

Characteristics

- * Two versions:
 - SIGMATEST Ec for standard applications
 - SIGMATEST D with extended scope of functions

Common characteristics of SIGMATEST Ec and SIGMATEST D

- * Fast and reliable determination of measured values at high accuracy
- * Large measuring range from 0.5 to 65 MS/m (1% to 112% IACS)
- * Clearance compensation up to 500 µm (.02 inch)
- * Consistently high accuracy on workpieces of various thickness
- * Four selectable measuring frequencies
- * Consistently high accuracy through to the edge of the material
- * Probe and probe cable can be replaced separately

- * Recalibration necessary only when requested by the instrument
- * Serial interface RS 232 for data output to a PC or printer
- * Spray-water-protected housing
- * Leak-proof battery compartment

Additional characteristics of the SIGMATEST D

- * Statistical evaluation programs
- * Measured values memory for 10,000 measured values, buffered by battery
- * Memory card for storing and cataloging measured values and for storing and reloading instrument settings
- * Temperature compensation by a temperature sensor integrated in the probe or with the aid of an external temperature sensor

Function

Measurement principle

The instrument operates on the basis of the eddy-current method. It determines the electrical conductivity of non-ferromagnetic metals. This permits conclusions to be drawn as regards to the composition, structure and condition of the material.

Operation

The instrument is ready for use immediately after switching on. The SIGMATEST Ec offers one standard operating mode and is thus particularly easy to operate. The SIGMATEST D has a program selection feature permitting the operator to call various operating modes and special additional functions.

Operating modes

Mode	Function	Measured value representation	SIGMATEST Ec	SIGMATEST D
Standard mode	Conductivity measurement	Touch mode	Yes	Yes
		Free run	No	Yes
Sort mode	Sorting into four classes	Touch mode	No	Yes
Limit mode	Sorting with an upper limit and lower limit	Touch mode	No	Yes

Standard mode with touch-mode representation

When the probe is lowered onto the workpiece, the instrument records the measured value and displays it on the display until the next time the probe is lowered onto material.

Frequency selection

Four different frequencies of 60, 120, 240 and 480 kHz permit measurements to be conducted on workpieces of various thickness with constantly high accuracy. This eliminates the need to use the correction factors for thin aluminum sheets.

Clearance compensation

The automatical clearance compensation allows measurements even if there are non-conductive layers on the workpiece, e.g. dust, enamel or paint coatings up to a thickness of 500 µm (.02 inch).

Temperature monitoring

The calibration standards are calibrated at a temperature of 20 °C (68 °F). Therefore the SIGMATEST achieves its highest measuring accuracy at this temperature.

Changes in temperature influence both the probe response and the conductivity of the material to be tested. They can be corrected by recalibration.

The instrument monitors the temperature with the aid of a temperature sensor integrated in the probe and signals automatically when it is necessary to recalibrate.

Additional functions of the SIGMATEST D

Standard mode with free-run representation

Measurement is conducted continuously in this operating mode. The display always shows the current measured value.

Sorting limits in Sort and Limit operating modes

Different conductivity classes can be defined by means of freely selectable limits. Four classes can be defined in Sort mode and one class in Limit mode.

Internal memory

Measured values and instrument settings can be stored, managed and reloaded in the internal memory. The memory has a capacity for up to 10,000 measured values.

External storing on a memory card

Measured values and instrument settings can be copied onto a memory card and reloaded from it. This allows the results of regular inspections to be cataloged over years.

Statistical evaluation

The SIGMATEST D permits the following statistical evaluation:

- * Mean value, standard deviation and number of the measured values of a measuring series
- * Distribution of the measured values in the conductivity classes in Sort and Limit operating modes

The results can be shown on the display and stored together with the instrument setting.

Temperature compensation

The SIGMATEST D compensates for temperature related conductivity variations. There are two ways:

- * Compensation with a temperature coefficient stored at the factory
- * Compensation with a temperature coefficient input by the operator. This allows optimization of the compensation for specific materials

The necessary temperature measurement can be performed optionally by using the temperature sensor integrated in the probe or by connecting an external temperature sensor. An external temperature sensor is recommended if the material temperature differs from the probe temperature.

Construction

SIGMATEST Ec testing device

- * Easy-to-operate, self-explanatory function keypad. No multi-function keys.
- * Light, ergonomically formed measuring instrument for laboratory and field use.
- * Clear, almost reflection-free LCD display. The instrument setting and measured value are visible at a glance.
- * Visual and/or audible signaling for various events, e.g. limit transgression, calibration recall, battery discharge, etc.

Separate connectors for:

- * Probe
- * RS 232 interface
- * Power supply
- * Compartment with two removable calibration standards.
- * Leak-proof battery compartment for four Ni/Cd "AA" re-chargeable batteries or four standard "AA" alkaline cells.
- * Brief operating instructions printed on the underside of the instrument.
- * Rating plate for instrument and probe identification number on the underside of the instrument.

SIGMATEST D testing device

As for SIGMATEST Ec testing device, but also:

- * Connector for external temperature sensor
- * Memory card slot in the compartment beneath the calibration standards

The keypad assignment differs from that on the SIGMATEST Ec. Keys have a dual assignment, thus permitting you to call additional functions.

Standard functional sets and standard components

Figures 3 and 4 show an overview of the standard components available for the SIGMATEST Ec and SIGMATEST D and the combination of the most important components into functional sets. In the following, you find the description of the main components.

Standard functional sets

The standard functional sets contain everything that is needed for normal use of the instrument. The sets with 230V power supply unit are scheduled for countries with mains power in accordance with DIN IEC 38. The sets without power supply unit are intended for countries whose mains power differs from this standard. Your local FOERSTER representative can supply you with an appropriate power supply.

Accessories and services for SIGMATEST Ec and SIGMATEST D

Power supply

The instrument can be operated alternatively with:

- * Four Ni/Cd "AA" rechargeable batteries
- * Four "AA" alkaline cells (1.5V IEC LR6)
- * A power supply

Carrying accessories

- * Case - For transportation and storage of the instrument, probes, and accessories.
- * Carrying bag - For wearing over the shoulder. Accommodates the instrument for mobile use.

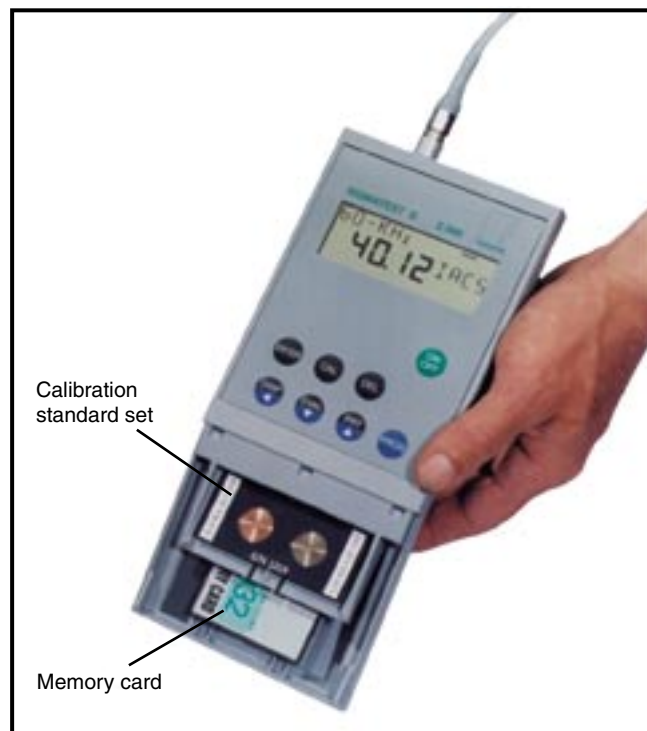

• Figure 2 - SIGMATEST D, housing opened, calibration standard set and memory card visible

Probes and accessories

A suitable probe and probe cable for connection to the testing device are necessary for operation.

* **Probe D=14 mm with handgrip**

Standard probe with handgrip and an Allen key for fixing the handgrip. The handgrip helps to isolate the probe from the operator's body temperature and thus ensures higher measurement accuracy. The handgrip and Allen key can be reordered as spare parts.

* **Set-down prism for probe D=14 mm**

The set-down prism serves as a support when testing round stock.

* **Angle probe D=14 mm**

Probe with a handgrip angled at 90° for testing at less accessible points.

* **Probe D=8 mm with handgrip with prism**

Probe for testing at small measuring areas and of material with a small radius. The handgrip and prism can be reordered as spare parts.

Conductivity standards and accessories

Conductivity standards serve for calibrating the instrument before use. All standards offered are certified and are themselves calibrated on the basis of national standards so that all measurements are traceable back in compliance with the requirements of ISO 9000.

* **Conductivity standard set 58MS/m (100% IACS), 2.39MS/m (4.12% IACS)**

This set is supplied together with the standard functional sets and consists of materials with conductivity values that lie at both ends of the measuring range. Calibration using this set is suitable for measurements over the entire measuring range.

* **Calibration standard set**

This calibration set is available as an option.
CALIBRATION STANDARD SET (3 STDS.) SPECIAL,
17.40 MS/m (30% IACS); 24.36 MS/m (42% IACS);
34.8 MS/m (60% IACS)

The SIGMATEST features a serial RS 232 interface for connection to a printer or computer. All printers can be connected which have a serial interface and are compatible with the Epson FX8xx series.

* **Interface cable AT PC, printer**

Special cable, required for connection of a computer or printer to the SIGMATEST. The adapter set for printer or cable is required additionally for connection of a printer.

* **Printer with RS232C**

Epson printer available for stationary use.

Accessories, suitable only for SIGMATEST D

* **Memory Card 32k x 8 bit**

The memory card is used for storing and archiving of measured data, instrument settings, or measuring series.

* **Software PC**

Program for transfer and storage of individual data or entire data records to a PC.

Temperature sensor

Option for measuring the temperature of the material under test and for compensating for the temperature-related conductivity variation. A temperature sensor should be used if the material temperature differs from the probe temperature.

STANDARD SET 1482246

STANDARD COMPONENTS

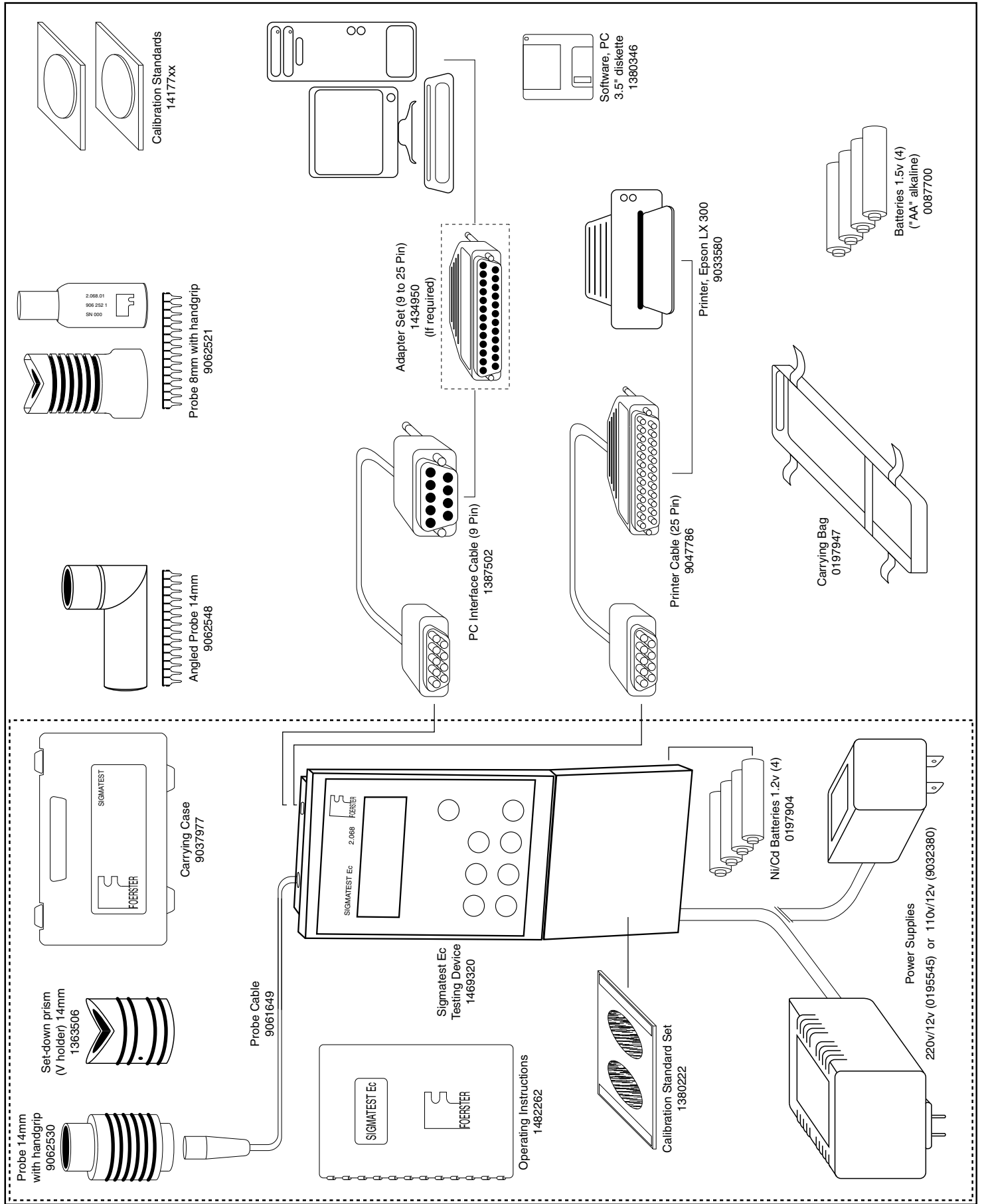

Figure 3 SIGMATEST Ec - Overview of the standard components

STANDARD COMPONENTS

STANDARD SET 1394010

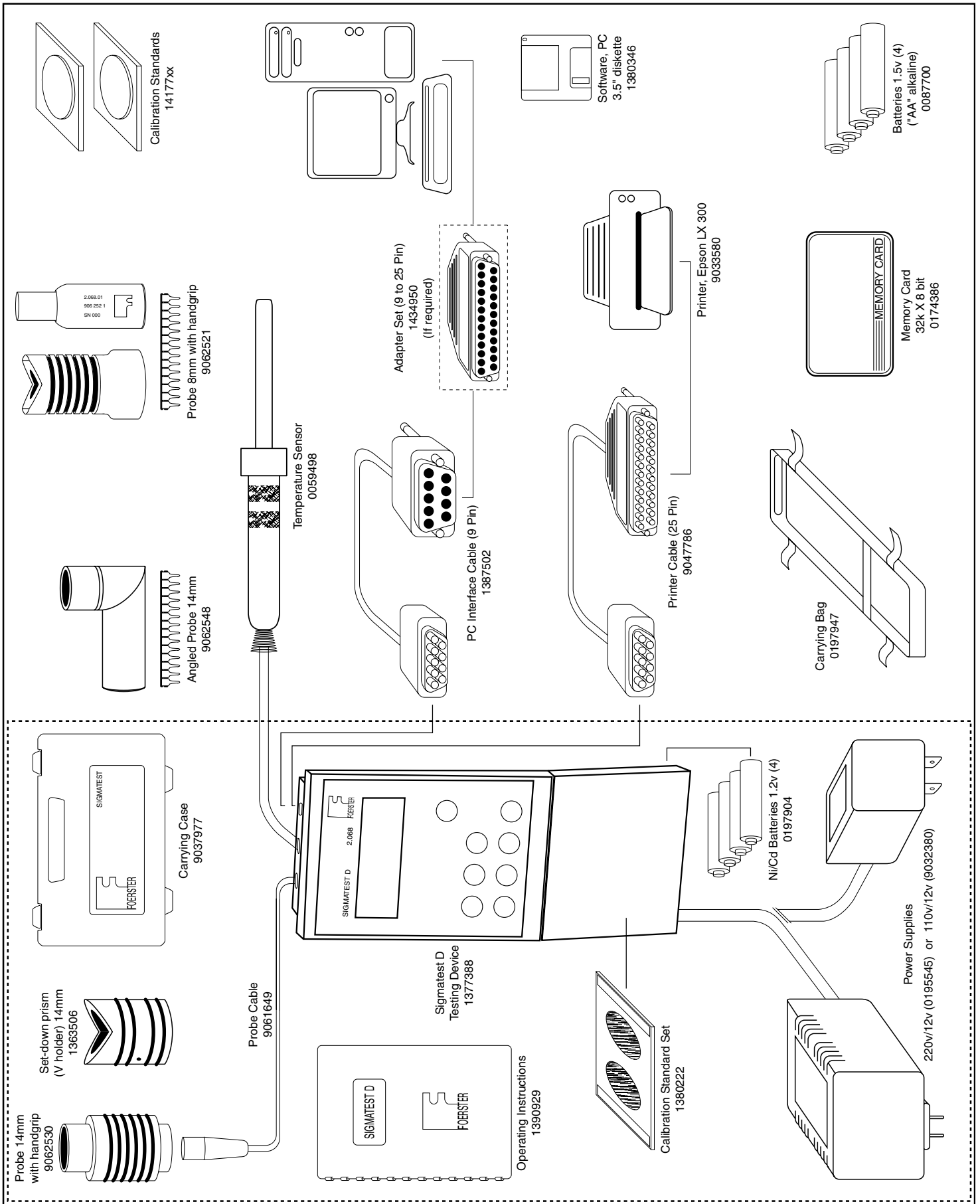

Figure 4 SIGMATEST D - Overview of the standard components

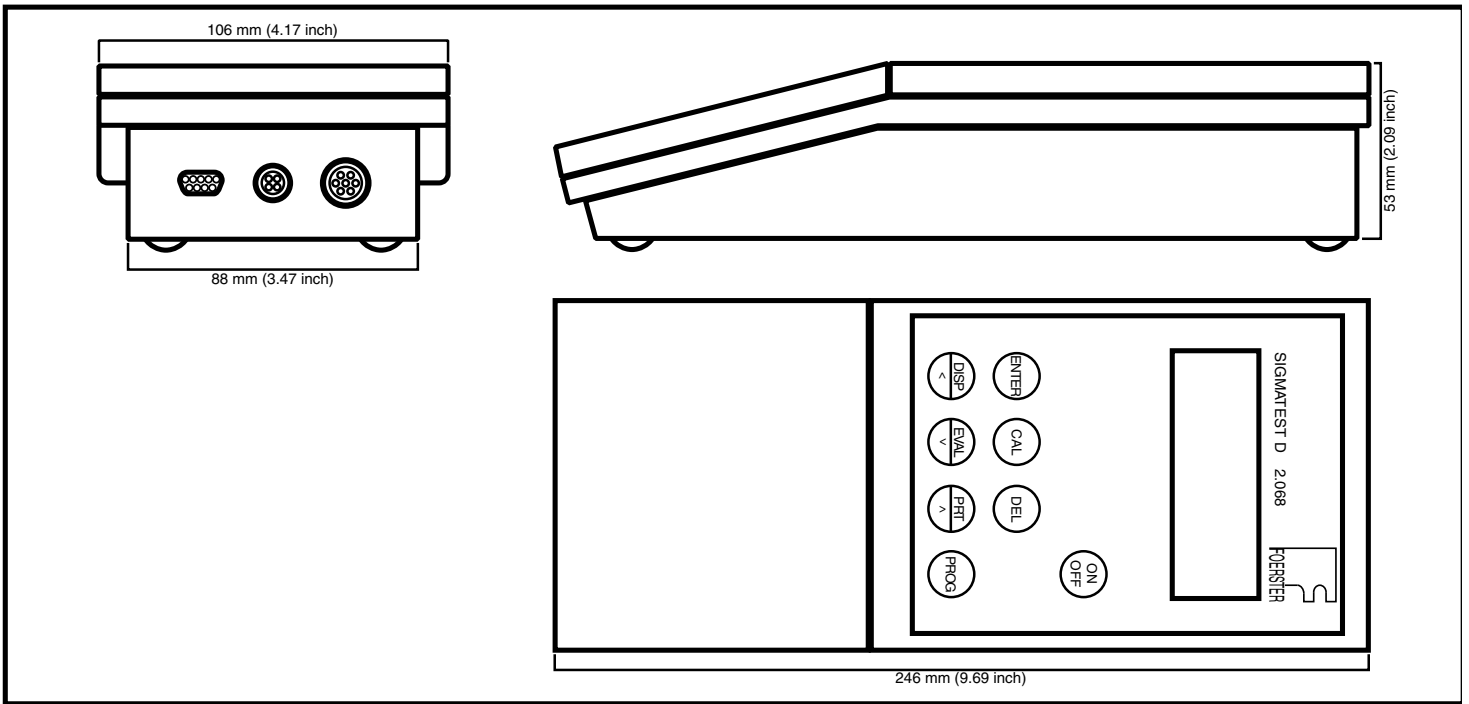

Figure 5 Dimension drawing SIGMATEST

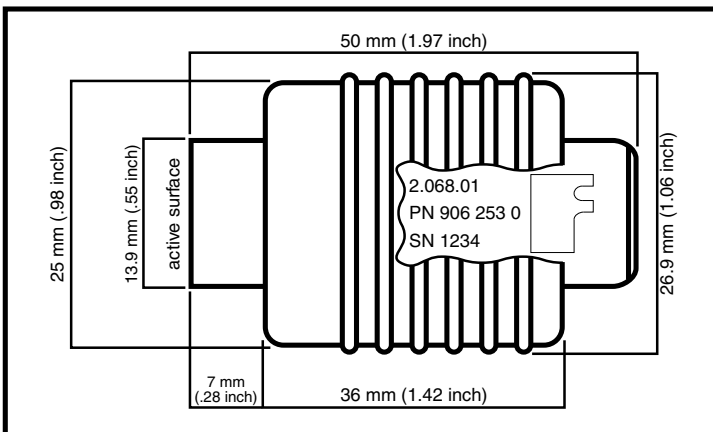

Figure 6 Dimension drawing probe 14mm

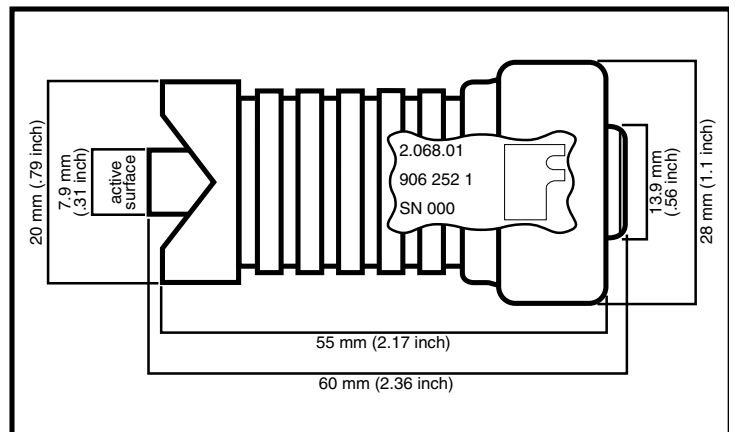

Figure 7 Dimension drawing probe 8mm

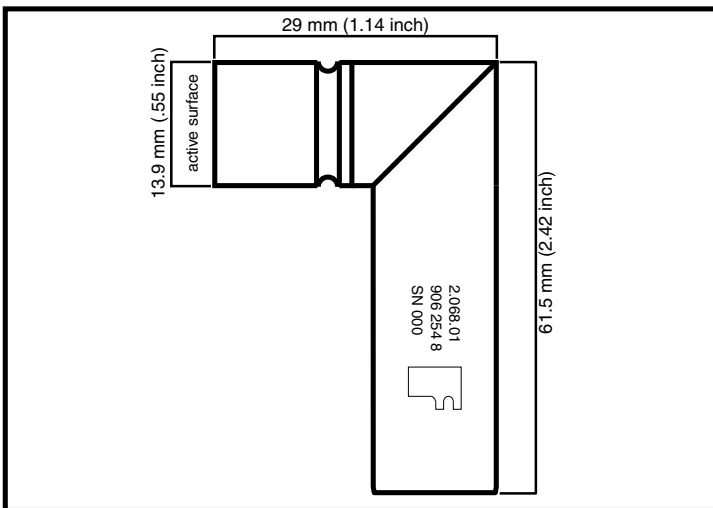

Figure 8 Dimension drawing angle probe 14mm

Technical data

Feature	SIGMATEST Ec	SIGMATEST D
Measuring ranges, selectable ¹	0.5 to 65 MS/m or 1 to 112% IACS ²	
Absolute accuracy	depending upon temperature, up to $\pm 1.5\%$ of measured value	$\pm 1\%$ of measured value
Resolution: for 60, 120 and 240 kHz for 480 kHz	$\pm 0.1\%$ of measured value $\pm 0.1\%$ for $.5 < \sigma \leq 30$ MS/m, $\pm 0.2\%$ for $30 < \sigma \leq 45$ MS/m, $\pm 0.3\%$ for $\sigma > 45$ MS/m	
Clearance compensation	to 500 μm (.02 inch)	
Frequencies, selectable	60, 120, 240, 480 kHz	
LCD display	4-digit, 7-segment display for the measured value 12 x 16 segment for instrument settings 10 status displays	
Keypad	membrane keypad with 8 keys	as for SIGMATEST Ec, but with different assignment
Interfaces for: probe serial RS 232 interface power supply unit external temperature sensor memory card	7-pole Lemo socket 9-pole MDS jack connector 3.5mm \varnothing no no	7-pole Lemo socket 9-pole MDS jack connector 3.5 mm \varnothing 4-pole Fischer socket 34-pole interface
Operating duration with one set of full: Alkaline batteries "AA", 4 ea. Ni/Cd rechargeable batteries, "AA" 4 ea.	8 hours 8 hours	
Memory internal RAM external memory card	no no	32 kBytes 32 kBytes
Protection class instrument probe	IP 53 (with closed compartment cover) IP 53	
Permitted ambient temperature instrument probe material temperature	0 to +55° C 0 to +55° C 0 to +70° C	
Mass measuring instrument	0.75 kg with accumulators 0.65 kg without accumulators	
Dimensions measuring instrument and probes	see figures 5 to 8	

¹ ? with probe D=8 and a frequency of 60 or 120 kHz, the measuring range is restricted to 2.5 to 58 MS/m (4 to 100% IACS)

² IACS = International Annealed Copper Standard, 100% IACS = 58 MS/m

SIGMATEST D

STANDARD SETS

Description	Part Number	ID Number
SIGMATEST D WITH 14MM PROBE 110V OR 220V (CUSTOMER TO SPECIFY) NSN NO. 6635 01 420 5318 KIT	2.068.82	1394010

Consisting of:

- 1 SIGMATEST D testing device
- 1 Operating instructions
- 1 Probe 14mm with hand grip
- 1 Set-down prism
- 1 Probe cable
- 1 Calibration standard set
- 4 Ni/Cd batteries (1.2v)
- 1 Case
- 1 Power supply 220v/12v
- or-**
- 1 Power supply 110v/12v (with 1 foam insert)

SIGMATEST D WITH 8MM PROBE 110V OR 220V (CUSTOMER TO SPECIFY)	2.068.83	9033718
--	-----------------	----------------

Consisting of:

- 1 SIGMATEST D testing device
- 1 Operating instructions
- 1 Probe 8mm with hand grip
- 1 Probe cable
- 1 Calibration standard set
- 4 Ni/Cd batteries (1.2v)
- 1 Case
- 1 Power supply 220v/12v
- or-**
- 1 Power supply 110v/12v (with 1 foam insert)

SIGMATEST D

STANDARD SETS

Description	Part Number	ID Number
SIGMATEST D WITH 14MM PROBE 110V OR 220V (CUSTOMER TO SPECIFY) NATO NO. 6635 90 980 1488 KIT	2.068.84	1472437

Consisting of:

- 1 SIGMATEST D testing device
- 1 Operating instructions
- 1 Probe 14mm with hand grip
- 1 Set-down prism
- 1 Probe cable
- 1 Calibration standard set
- 4 Ni/Cd batteries (1.2v)
- 1 Case
- 1 Temperature sensor
- 1 Interface cable AT
- 1 Software (PC)
- 1 Memory card
- 1 Power supply 220v/12v
- or-**
- 1 Power supply 110v/12v (with 1 foam insert)

SIGMATEST D (WITH AUTOMATIC SWITCH OFF DISABLED), WITH 14MM PROBE, 110V OR 220V (CUSTOMER TO SPECIFY) KIT	2.068.86	9063170
--	-----------------	----------------

Consisting of:

- 1 SIGMATEST D testing device with Auto Switch
Off disabled
- 1 Operating instructions
- 1 Probe 14mm with hand grip
- 1 Set-down prism
- 1 Probe cable
- 1 Calibration standard set
- 4 Ni/Cd batteries (1.2v)
- 1 Case
- 1 Power supply 220v/12v
- or-**
- 1 Power supply 110v/12v (with 1 foam insert)

SIGMATEST Ec

STANDARD SETS

Description	Part Number	ID Number
-------------	-------------	-----------

SIGMATEST Ec WITH 14MM PROBE 110V OR 220V (CUSTOMER TO SPECIFY) NSN NO. 6635 01 420 5322 KIT	2.068.92	1482246
---	-----------------	----------------

Consisting of:

- 1 SIGMATEST Ec testing device
- 1 Operating instructions
- 1 Probe 14mm with hand grip
- 1 Set-down prism
- 1 Probe cable
- 1 Calibration standard set
- 4 Ni/Cd batteries (1.2v)
- 1 Case
- 1 Power supply 220v/12v
- or-**
- 1 Power supply 110v/12v (with 1 foam insert)

SIGMATEST Ec WITH 8MM PROBE 110V OR 220V (CUSTOMER TO SPECIFY)	2.068.90	9033726
---	-----------------	----------------

Consisting of:

- 1 SIGMATEST Ec testing device
- 1 Operating instructions
- 1 Probe 8mm with hand grip
- 1 Probe cable
- 1 Calibration standard set
- 4 Ni/Cd batteries (1.2v)
- 1 Case
- 1 Power supply 220v/12v
- or-**
- 1 Power supply 110v/12v (with 1 foam insert)

SIGMA TEST D/Ec

STANDARD COMPONENTS

Description	Part Number	ID Number
STANDARDS		
Calibration Standard set (2 STDS.) 2.39 MS/m (4.12% IACS); 58 MS/m (100% IACS)	2.068.01	1380222
Calibration Special Standard set (3 STDS.) 17.40 MS/m (30% IACS); 24.36 MS/m (42% IACS); 34.8 MS/m (60% IACS)	2.068.01	9048944
Conductivity Standard .6 MS/m (1 IACS)	2.068.01	1417703
Conductivity Standard 4.4 MS/m (8 IACS)	2.068.01	1417720
Conductivity Standard 16 MS/m (28 IACS)	2.068.01	9063153
Conductivity Standard 17 MS/m (29 IACS)	2.068.01	1417754
Conductivity Standard 22 MS/m (38 IACS)	2.068.01	1417762
Conductivity Standard 30 MS/m (52 IACS)	2.068.01	1417797
Conductivity Standard 36 MS/m (62 IACS)	2.068.01	1417770
Conductivity Standard 58 MS/m (100 IACS)	2.068.01	1417789

NOTES:

- 1) All standards above are approximate in value
 - 2) Measurement of uncertainty: + OR - 0.5%
-

ACCESSORIES

Temperature Sensor	PRD52697B	0059498
Memory Card, 32k x 8 bit	BN-032MCE	0174386
Printer, Epson LX300	C130001	9033580
Printer Cable, 2M (25 pin)	2.068US	9047786
Adapter Set, 9 to 25 pin (for PC)	2.068.01	1434950
Interface Cable, PC AT (9 pin)	2.068.01	1387502
Software PC, 3-1/2" diskette (for sending measured values from the Sigmatest to a PC)	2.068.01	1380346

SIGMATEST D/Ec

STANDARD COMPONENTS

Description	Part Number	ID Number
-------------	-------------	-----------

INSTRUMENTS

Leaflet	2.068 UA01/E	1381997
Operating Instructions, SIGMATEST D	2.068 UA06/E	1390929
Operating Instructions, SIGMATEST Ec	2.068 CUA06/E	1482262
SIGMATEST D testing device	2.068.01	1377388
SIGMATEST Ec testing device	2.068.01	1469320
SIGMATEST D testing device, with Automatic Switch Off disabled	2.068.01	9063161
Case	2.068.01	9037977
Carrying Bag	2.068.01	0197947

POWER SUPPLIES

Ni/Cd Battery (1.2v)	VH1200AA	0197904
Battery, 1.5v (AA)	PC1500	0087700
Power Supply 220v/12v	11.7906	0195545
Power Supply 110v/12v	PIDB-201	9032380

PROBES

Probe, Standard, 14mm with handgrip	2.068.01	9062530
Probe, 8mm with handgrip	2.068.01	9062521
Probe, 14mm angled	2.068.01	9062548
Set-down Prism (V-holder) 14mm	2.068.01	1363506
Set-down Prism (V-holder) 8mm	2.068.01	1461834
Probe handgrip	2.068.01	1419404
Probe cable	2.068.01	9061649

Should you have any questions, please contact:

FOERSTER INSTRUMENTS INCORPORATED

140 Industry Drive
RIDC Park West
Pittsburgh, PA 15275-1028
Phone: (412) 788-8976
Fax: (412) 788-8984

E-mail: sales@foerstergroup.com
Web Site: www.foerstergroup.com

Information and illustration may be subject to change

Order No.		1484842
Edition	12/00	
Author	Do	